

75系列卫生间平开门结构图

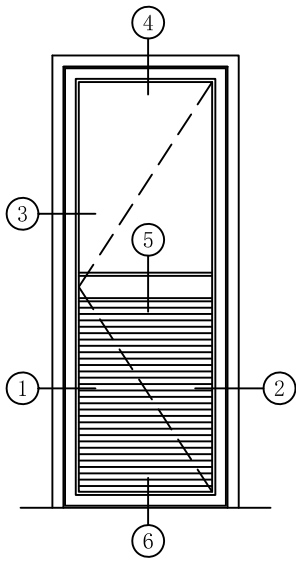

标准门: 0.9mX2.1m, 耗材约7.7kg/m²。

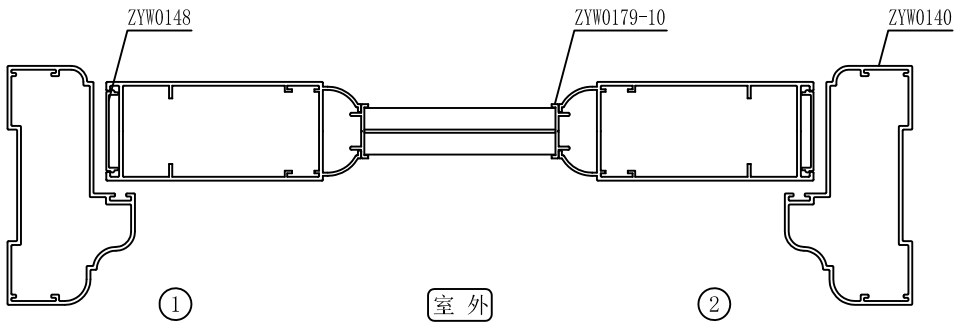
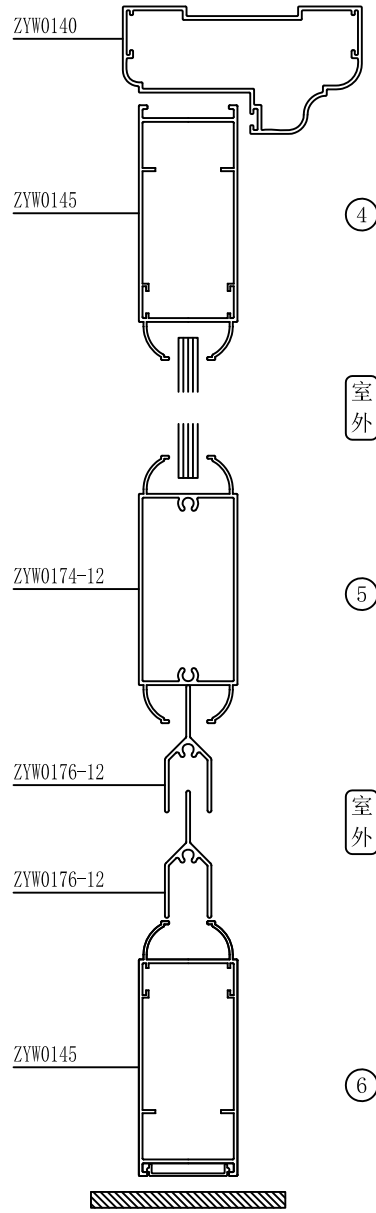
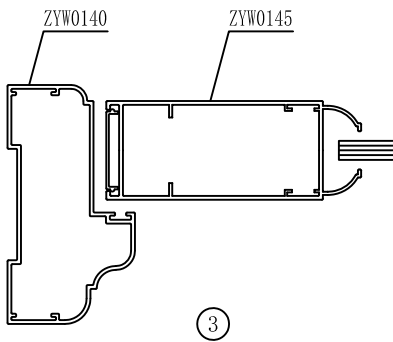

75系列卫生间平开门型材目录

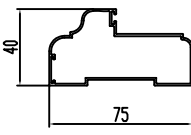
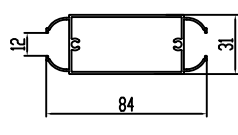
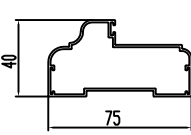
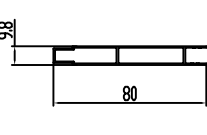
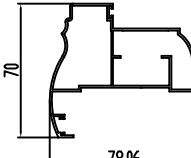
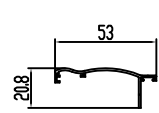
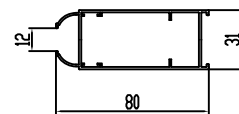
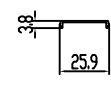
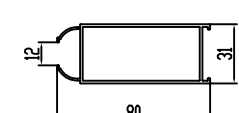
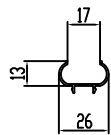
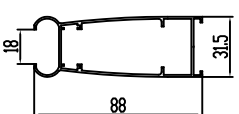
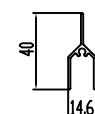
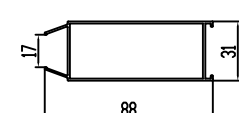
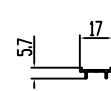
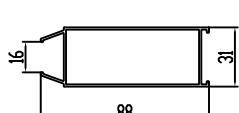
型材编号	图 例	型材编号	图 例	型材编号	图 例
名称		名称		名称	
壁厚T(mm)		壁厚T(mm)		壁厚T(mm)	
重量(kg/m)		重量(kg/m)		重量(kg/m)	
ZYW0140A		ZYW0174-12			
平开门框		门中方			
T=1.0		T=1.2			
0.648 kg/m		0.810 kg/m			
ZYW0140		ZYW0178			
平开门框		双面扣板			
T=1.2		T=0.8			
0.758 kg/m		0.408 kg/m			
ZYW0140C		ZYW0169C			
平开门框		门包边			
T=1.1		T=1.1			
0.977 kg/m		0.246 kg/m			
ZYW0145		ZYW0148			
圆边门企		门企盖板			
T=1.2		T=0.8			
0.761 kg/m		0.070 kg/m			
ZYW0145A-14		ZYW0152			
圆边门企		中空槽			
T=1.4		T=1.0			
0.821 kg/m		0.148 kg/m			
ZYW0145B		ZYW0176-12			
门企		百页			
T=1.1		T=1.2			
0.780 kg/m		0.246 kg/m			
ZYW0147A		ZYW0179-10			
斜边门企		百页框			
T=1.1		T=1.0			
0.718 kg/m		0.070 kg/m			
ZYW0147					
斜边门企					
T=1.2					
0.772 kg/m					